



**marmox**<sup>®</sup>

**MARMOX SHOWER TRAY SYSTEM**  
INSTALLATION MANUAL

# table of contents

01 ..... Marmox Shower Tray System

---

02 ..... Marmox Shower Tray on Timber Floors

---

06 .. Marmox Shower Tray on Concrete Floors

---

08 ..... Shower Tray Extension Size

---

08 ..... Shower Hob Sizes

---

08 ..... Center Drain Sizes

---

09 ..... Offset Drain Sizes

---

09 ..... Trough Drain Sizes

**Marmox**

**Innovative  
Construction  
&  
Insulation  
Solutions**





The Marmox Shower Tray System is available with an extruded polystyrene core or as a solid shower stone base.

The extruded polystyrene shower tray has a fiberglass mesh embedded into a cement polymer mortar on each side. It must be fully supported by a structured floor. It is ideal for wet rooms and showers in confined locations. It can be easily cut to fit the shower area or to produce an irregular or circular shower base.

Unlike some other underlays, the Marmox Shower Tray System is sufficiently robust allowing 100mm tiles or waterproof sheeting to be laid on it without the risk of compression through point loading.

The solid shower stone tray is made of polymer (acrylic) modified concrete. It does not need to be fully supported by a structured floor. This is the main advantage of the solid shower stone as it can be fixed directly to the floor joist. It can be finished either by tiles, mosaics, or vinyl.

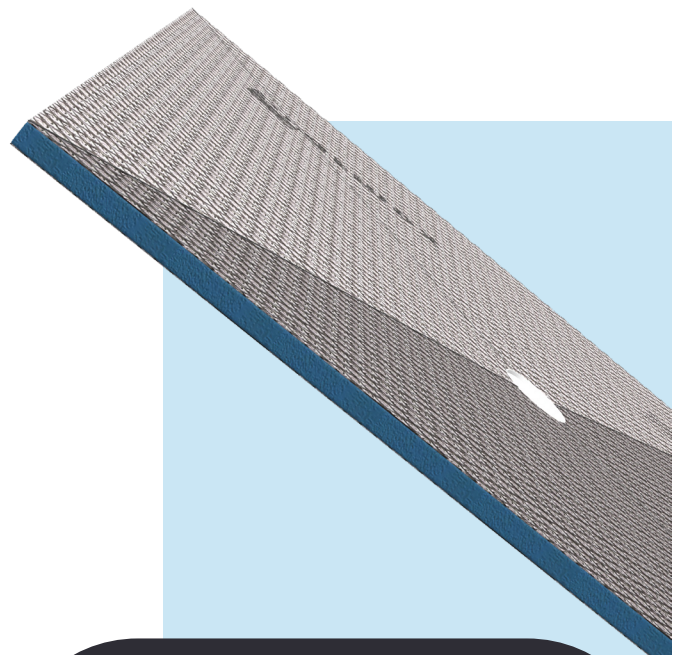

**EXTRUDED  
POLYSTYRENE**  
*Light weight & easy to cut*



**SHOWER STONE**  
*Can be fixed directly to floor joist*

# 1 Marmox shower tray on timber floors

## *Hobless Construction*

This Involves cutting the floor boards where the Marmox shower tray will drop into.

### **A. FOR MARMOX SHOWER STONE BASE**



1. Check the timber floor for flatness and level. Support the solid base shower tray along the four edges and around the drain hole.
2. Follow steps 3-7 below.



## B. FOR BOTH MARMOX SHOWER STONE AND UNDERLAY

### Step 3

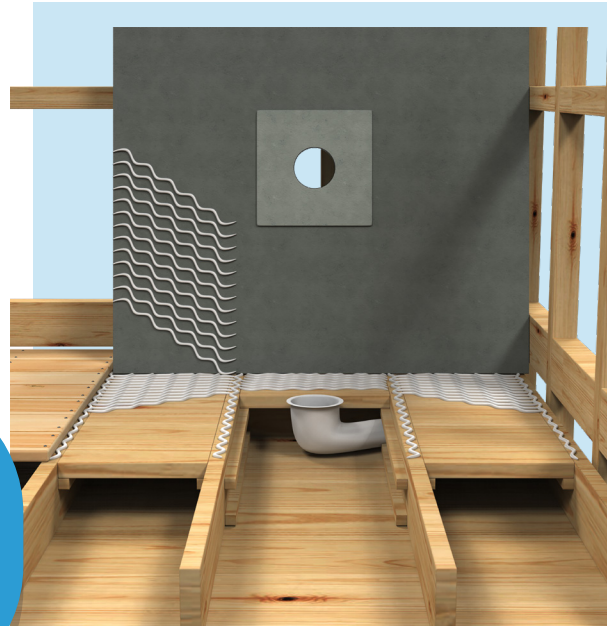

3. Use a polyurethane adhesive (non-solvent based) to glue down the underlay to the floor.

### Step 4

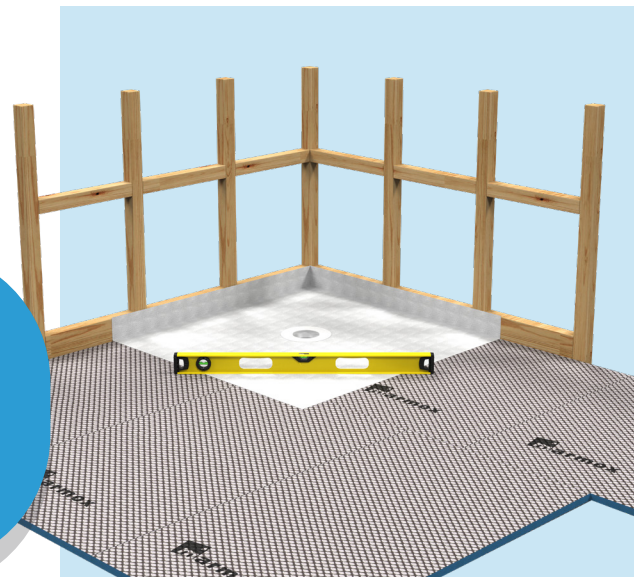

4. Place the underlay in position, apply downward pressure on the underlay and check for level.



## Step 5

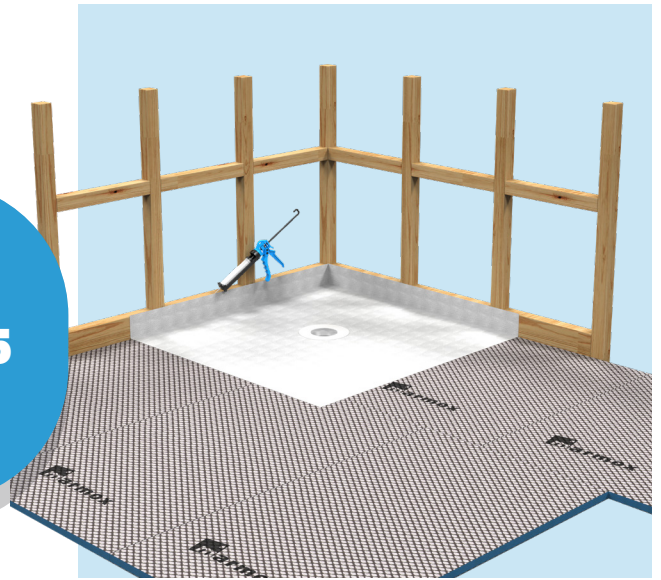

5. Use the same adhesive to glue the loose ends of the fleece to the wall and the floor.

## Step 6

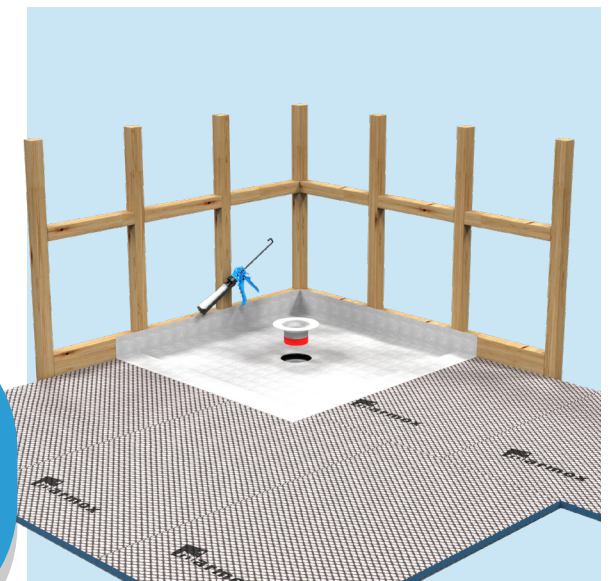

6. Apply a bead of polyurethane on the stainless-steel plate and plumber's glue to the drainpipe. Then fix the drainage flange in position and apply a bead of polyurethane to the outside of the flange.





## Step 7

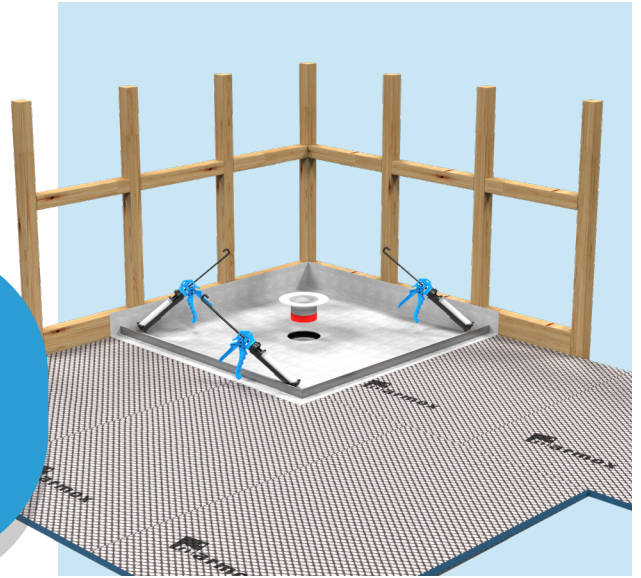

7. Fix a suitable height aluminum angle to the outside line of the MARMOX underlay or shower stone as a water stop using polyurethane adhesive.

## Step 8

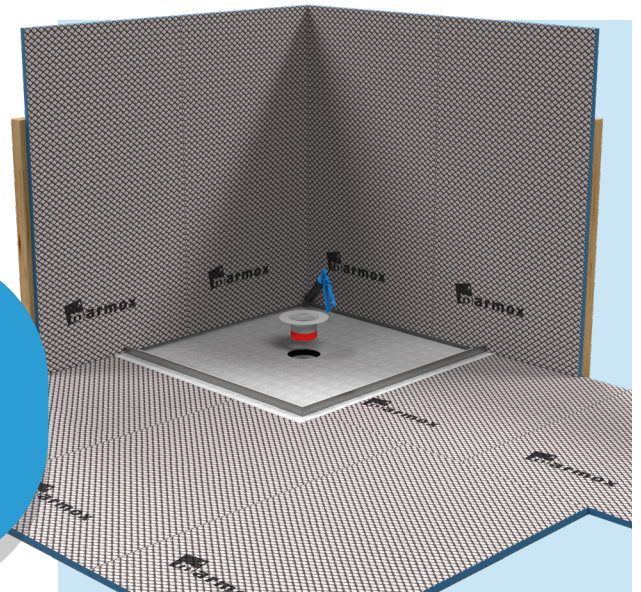

8. After the shower tray system is in place, install the wall sheeting. Tile as usual.

# 2 Marmox shower tray on concrete floors

## *Hob Construction*

This is perfect for applying the shower tray with concrete slabs. It combines a full Marmox floor covering and a shower tray with a hob construction.

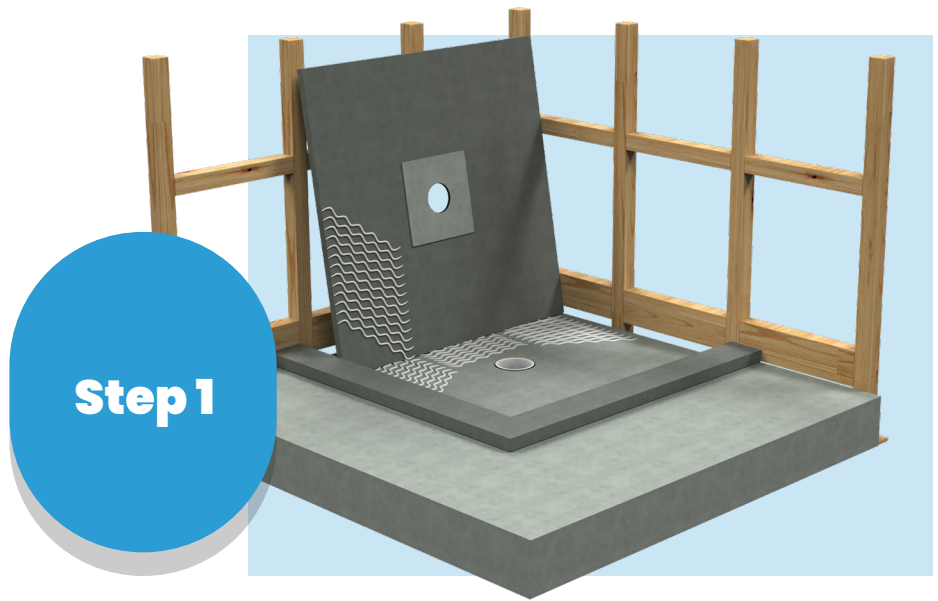

1. Apply cement based tile adhesive on the base and the floor using 10mm notched trowel to glue down the underlay to the floor.

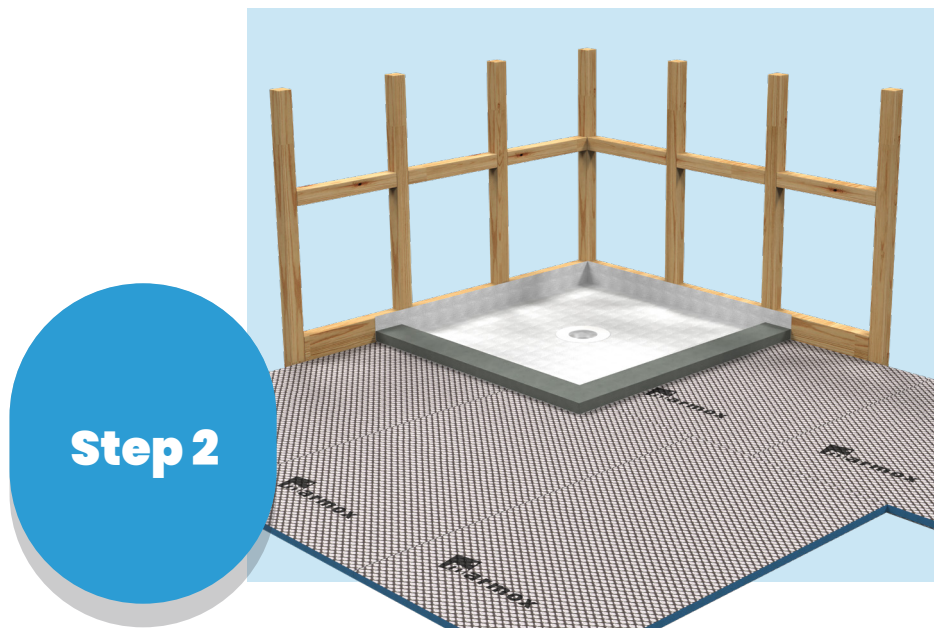

2. Place the underlay in position, apply downward pressure on the underlay and check for level. Use the same adhesive to glue the loose ends of the fleece to the wall and the floor.



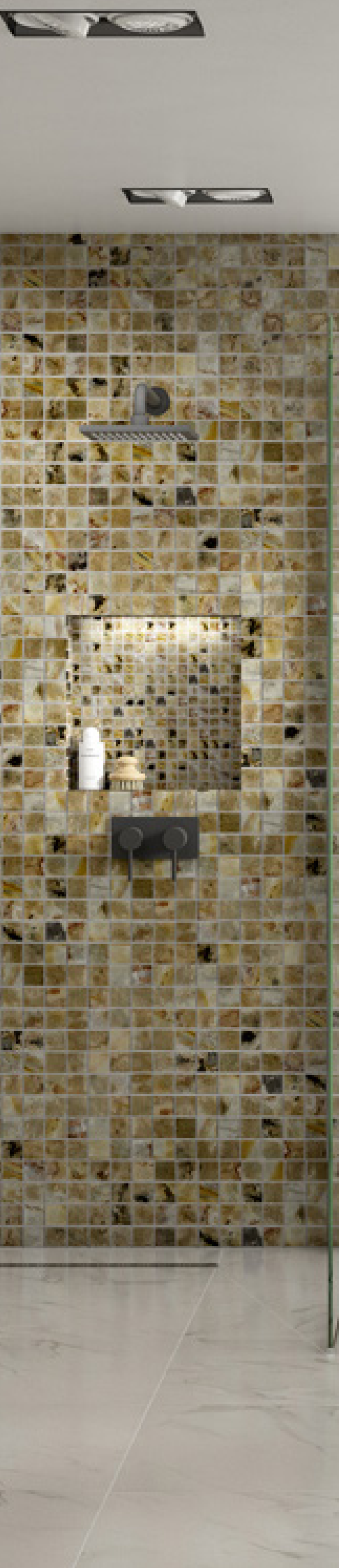

### Step 3

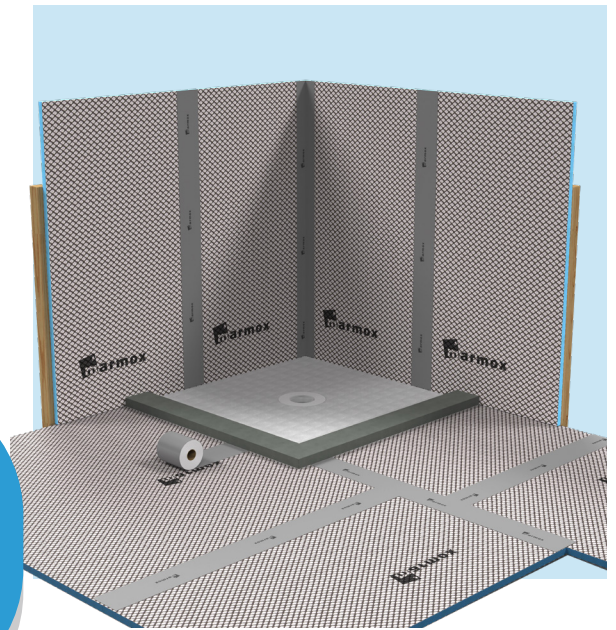

3. Apply a bead of polyurethane on the stainless-steel plate and plumber's glue to the drainpipe. Then fix the drainage flange in position and apply a bead of polyurethane to the outside of the flange. After the shower tray system is in place, install the wall sheeting, Seal joints with MARMOX sealing tape and cover all washers with MS Polymer.

### Step 4

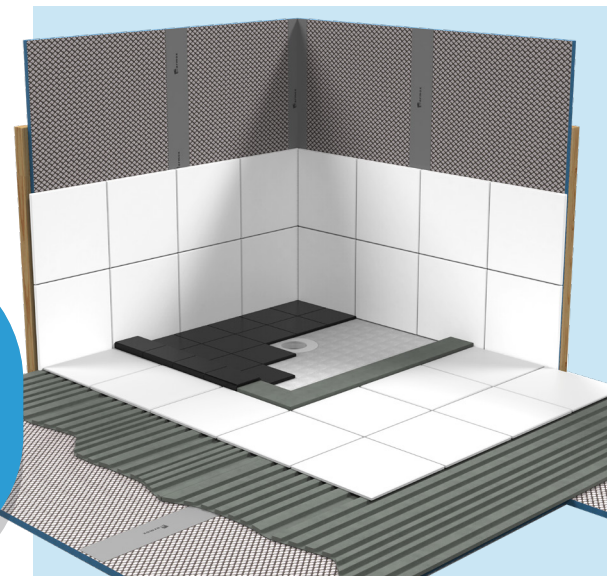

4. Tile as usual.



## SHOWER TRAY EXTENSION SIZE

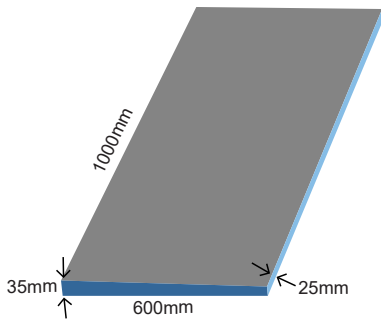

## SHOWER HOB SIZES

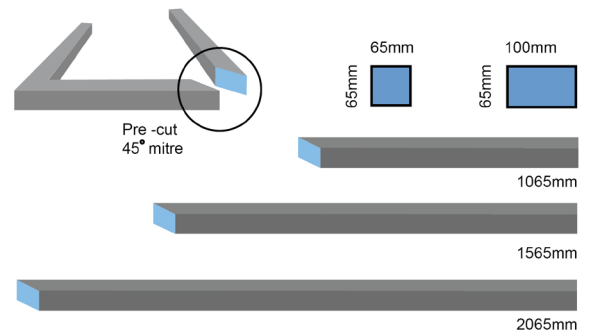

## CENTER DRAIN SIZES

Other dimensions available on request

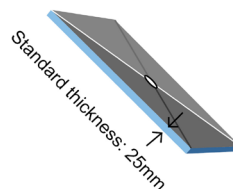
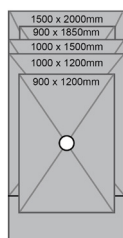
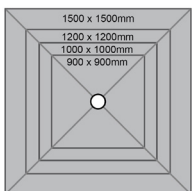



## OFFSET *DRAIN SIZES*

Other dimensions available on request

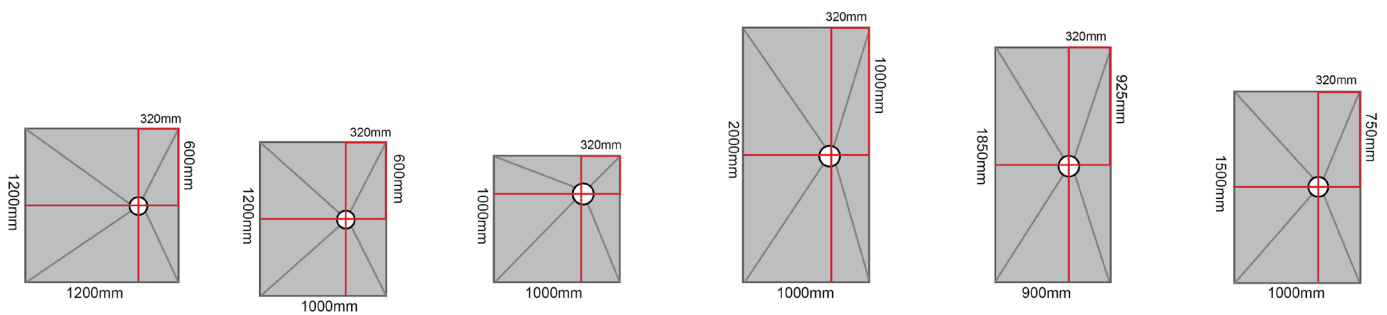

## TROUGH *DRAIN SIZES*

Other dimensions available on request

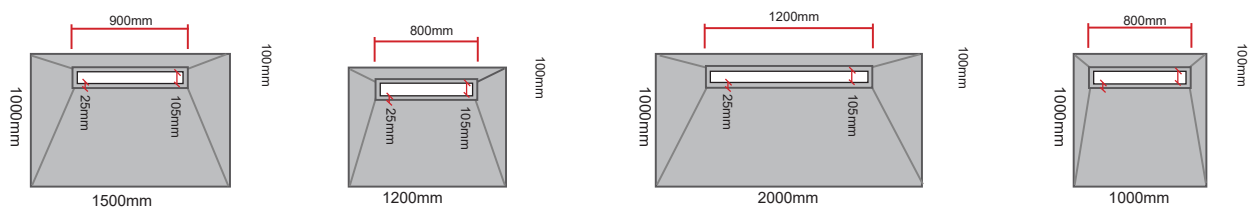
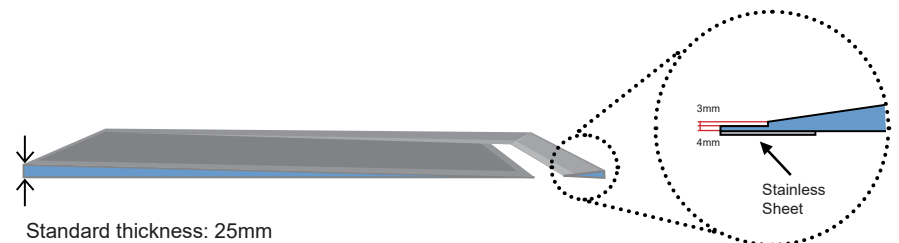





DESCRIPTION	CENTRE	OFFSET	TROUGH
Shower Underlay 900mm x 900mm	X		
Shower Underlay 1000mm x 1000mm	X	X	X
Shower Underlay 900mm x 1200mm	X		X
Shower Underlay 1000mm x 1200mm	X	X	
Shower Underlay 1200mm x 1200mm	X	X	
Shower Underlay 1000mm x 1500mm	X	X	X
Shower Underlay 900mm x 1850mm	X	X	
Shower Underlay 1000mm x 2000mm	X	X	X
Shower Underlay 1500mm x 1500mm	X		
Solid Underlay 900mm x 900mm	X		
Solid Underlay 1000mm x 1000mm	X	X	
Solid Underlay 900mm x 1200mm	X		
Solid Underlay 1000mm x 1200mm	X	X	
Solid Underlay 1200mm x 1200mm	X	X	
Solid Underlay 1000mm x 1500mm	X	X	



IT'S WHAT 'S UNDERNEATH THAT COUNTS

[www.marmox.com.au](http://www.marmox.com.au)